



# Bioprincipled Cities

---

Li Zhang, Tsinghua University

**Back to Rural China:**  
a Field of *Sustainable Design Innovations*

GBS 2015 | Berlin, Nov 2015 | ZHANG, Li | Tsinghua University, China





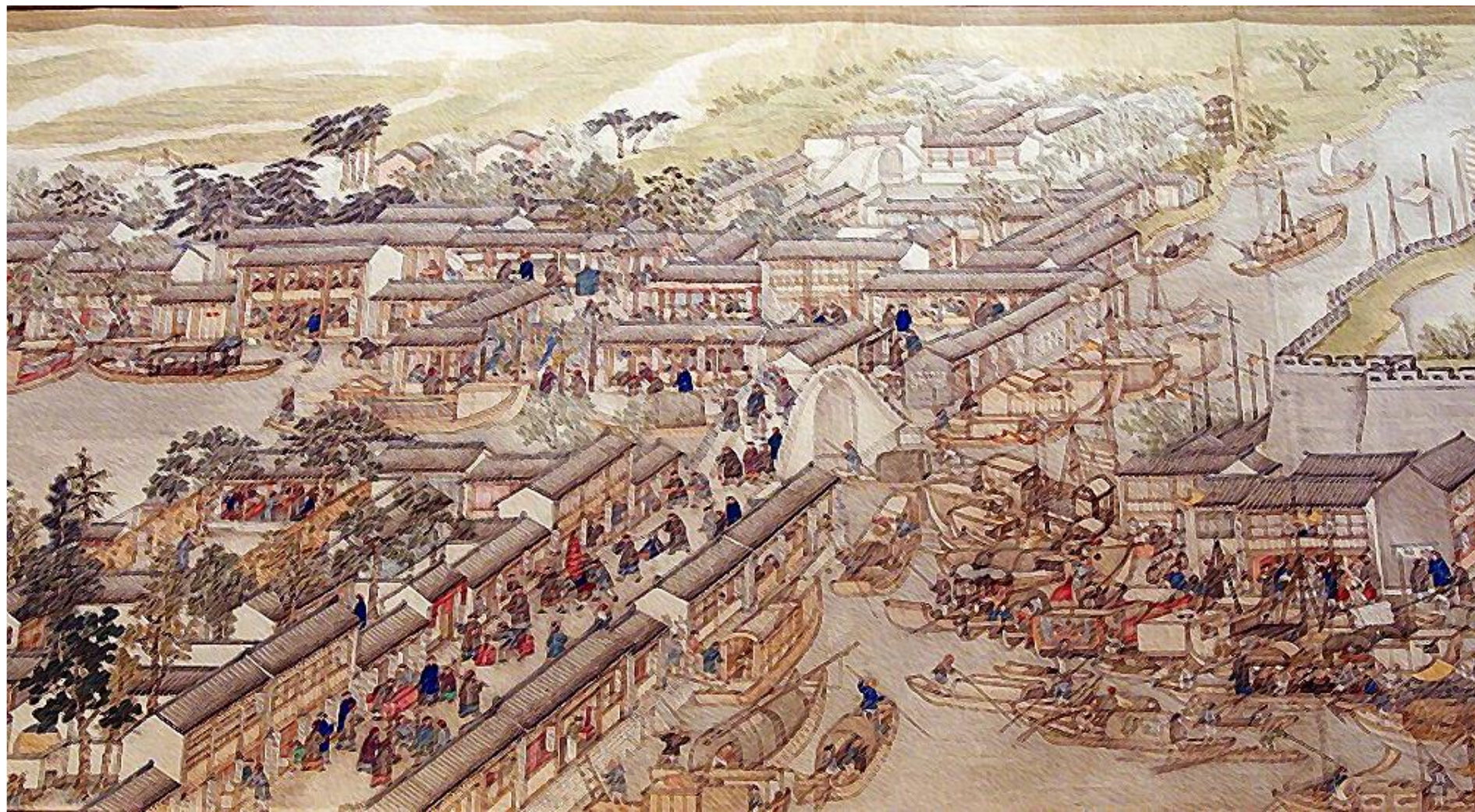

A Chinese Tradition | -1800s

The Village As the Enclave for Innovation  
experiments of autonomous intellectuals











# Massive Urbanisation | 1980s-2010s

## How Much Is Too Much

the over-concentration of everything and its consequences















Back to the Rural | 2010s-

For Equality, For Sustainability

rural China as a field of sustainable design innovations

Back to the Rural | 2010s-

For Equality, For Sustainability

rural China as a field of sustainable design innovations

'The New Chinese Village'

Back to the Rural | 2010s-

For Equality, For Sustainability

rural China as a field of sustainable design innovations

Driving force 1 \ Economy

# Back to the Rural | 2010s-

For Equality, For Sustainability

rural China as a field of sustainable design innovations

Driving force 1 \ Economy

Driving force 2 \ Land Ownership (Kind of)

# Back to the Rural | 2010s-

For Equality, For Sustainability

rural China as a field of sustainable design innovations

Driving force 1 \ Economy

Driving force 2 \ Land Ownership (Kind of)

Driving force 3 \ Mentality

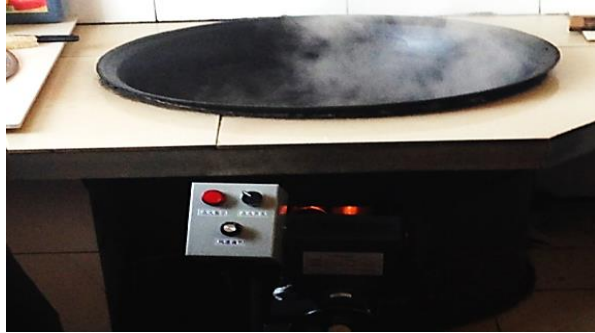

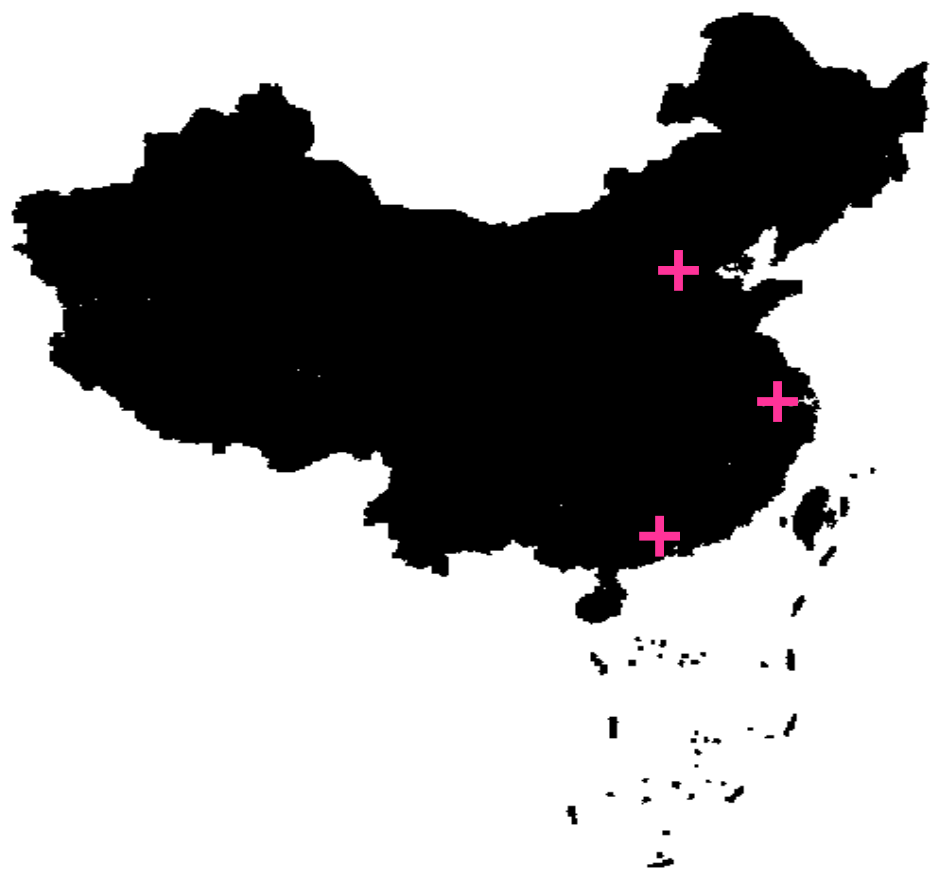



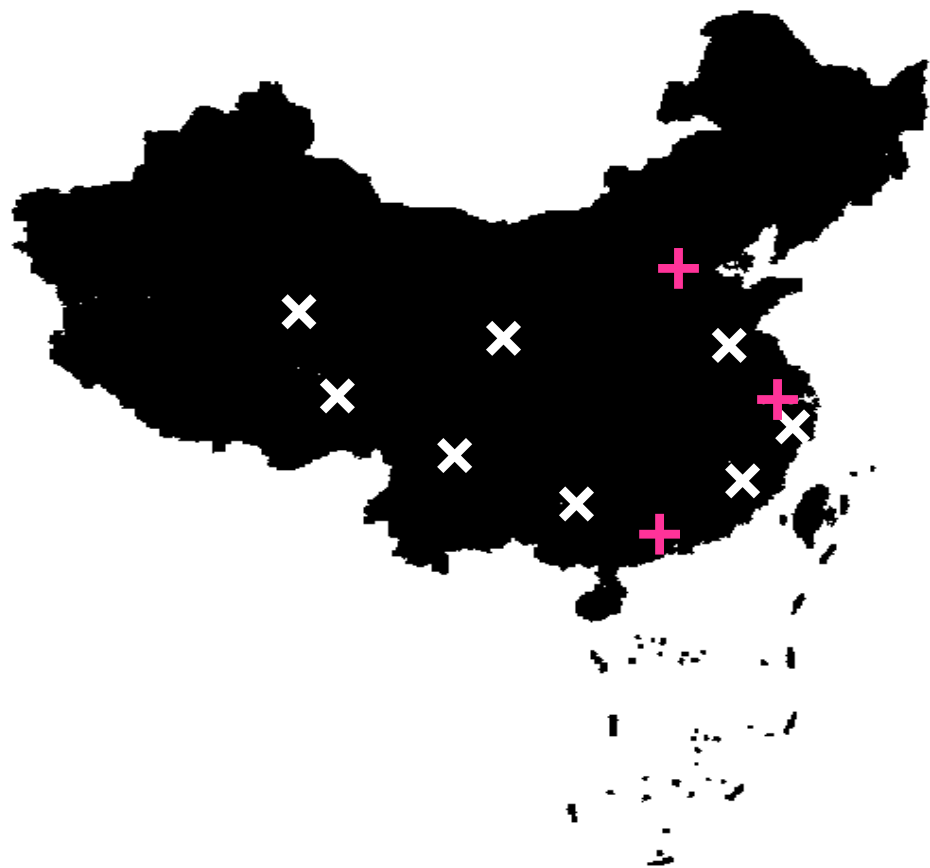

Back to the Rural | 2010s-

For Equality, For Sustainability  
rural China as a new field of design innovations

Approach 1 \ Rural Infrastructure







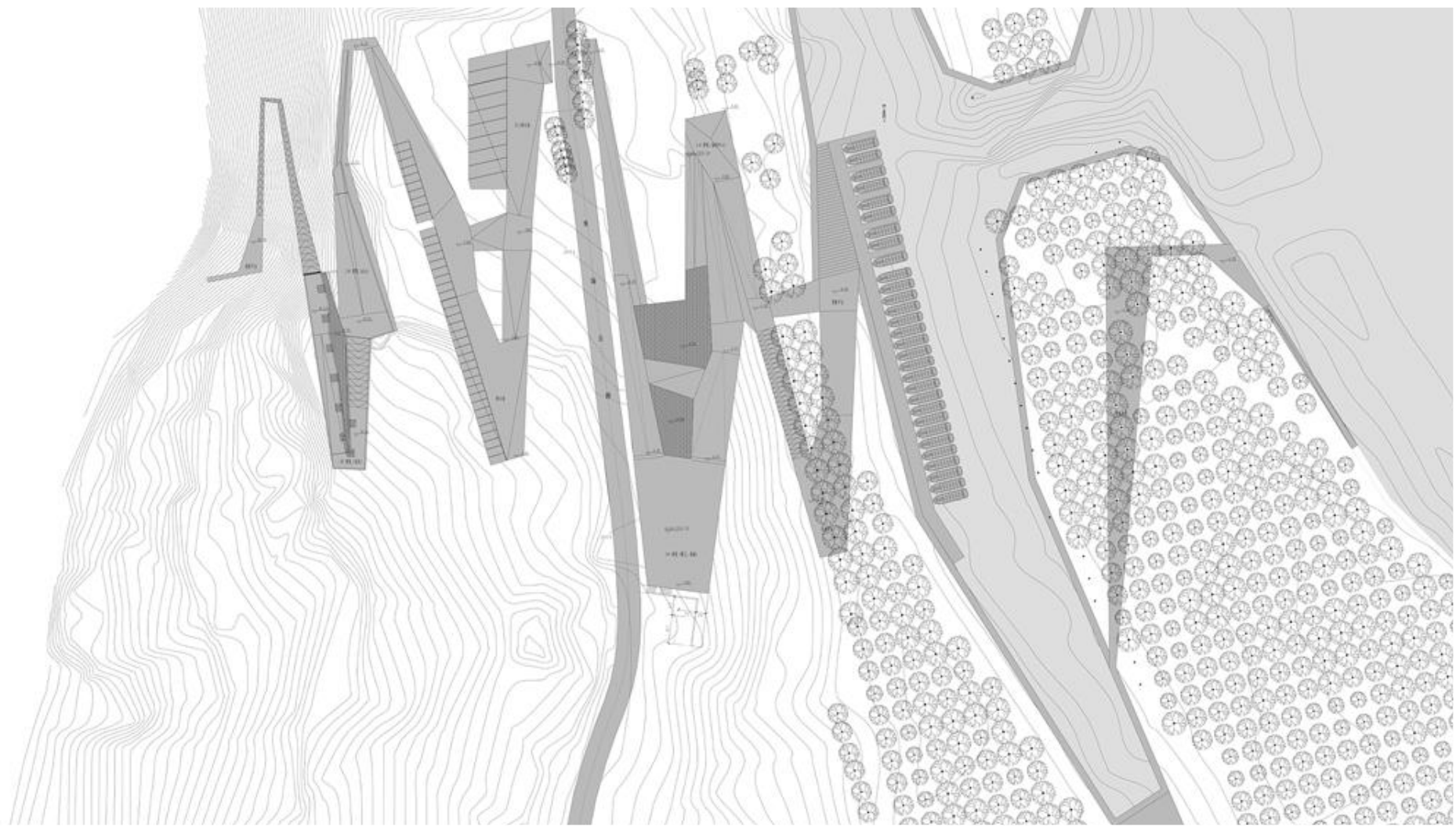



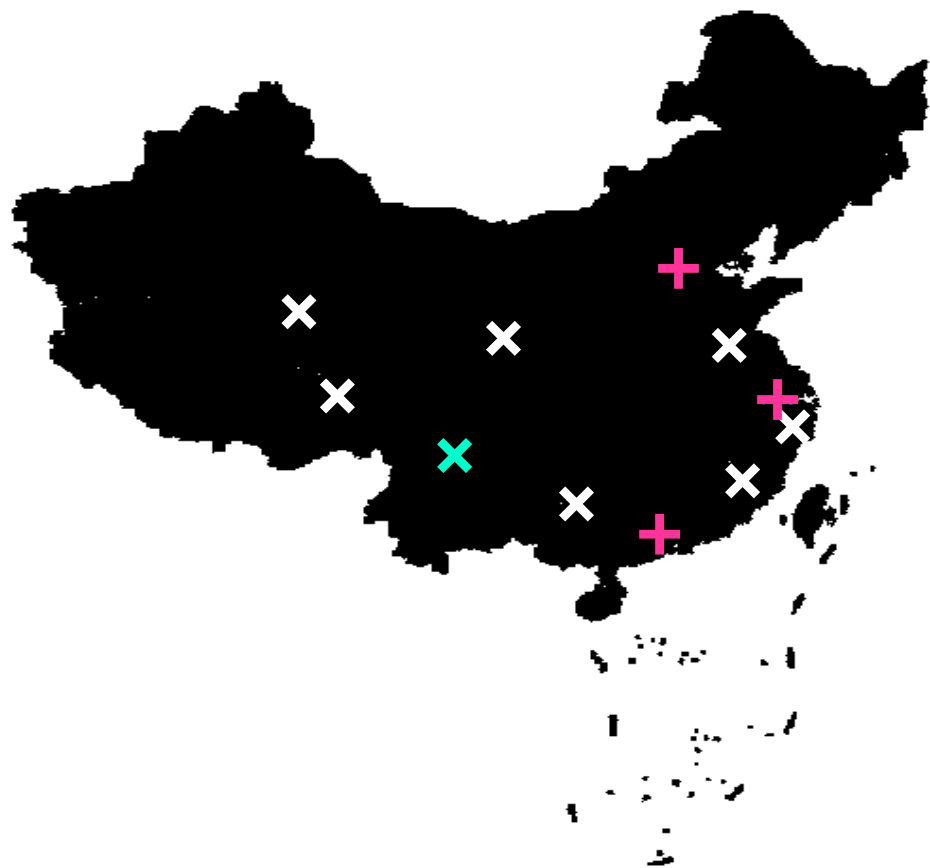



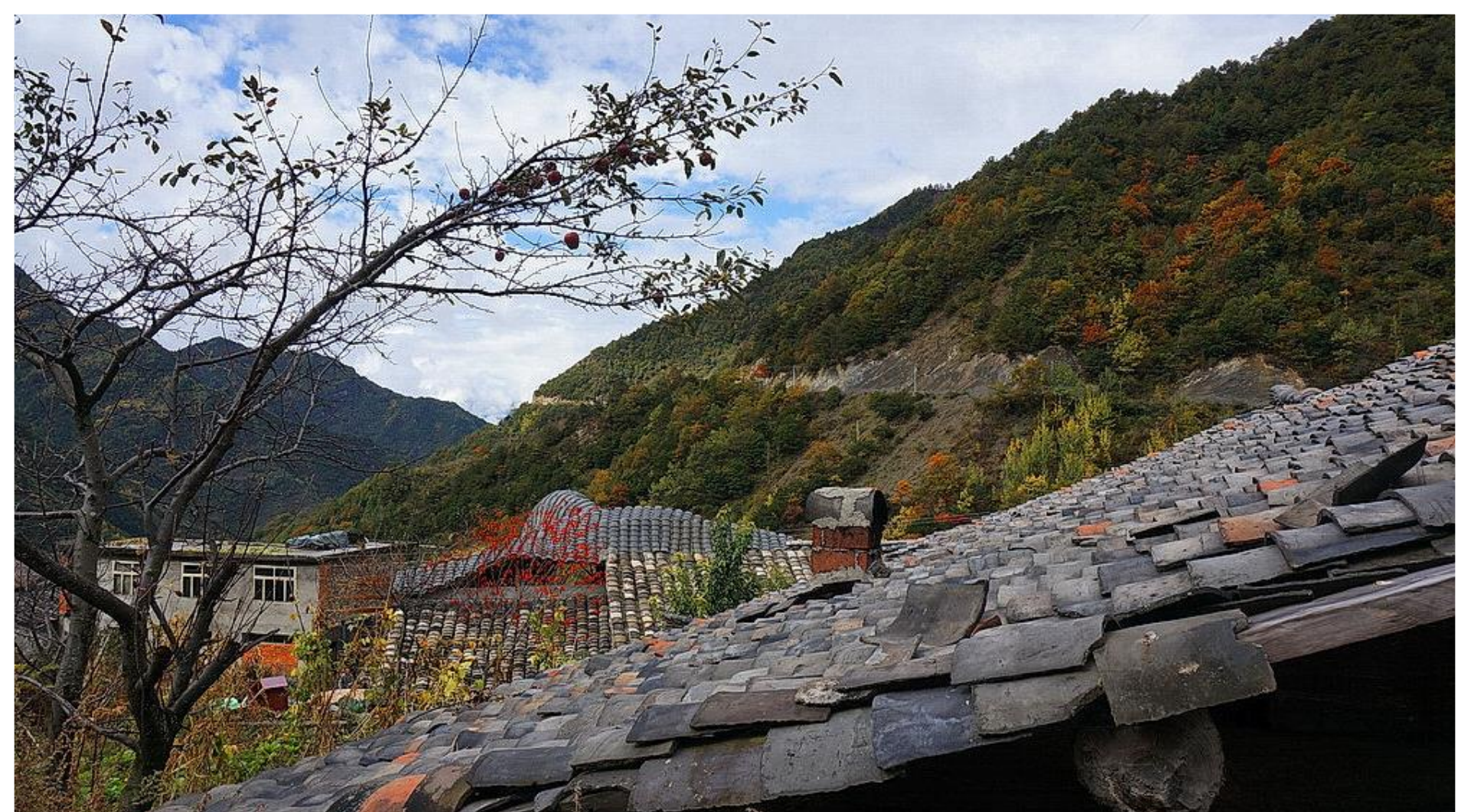



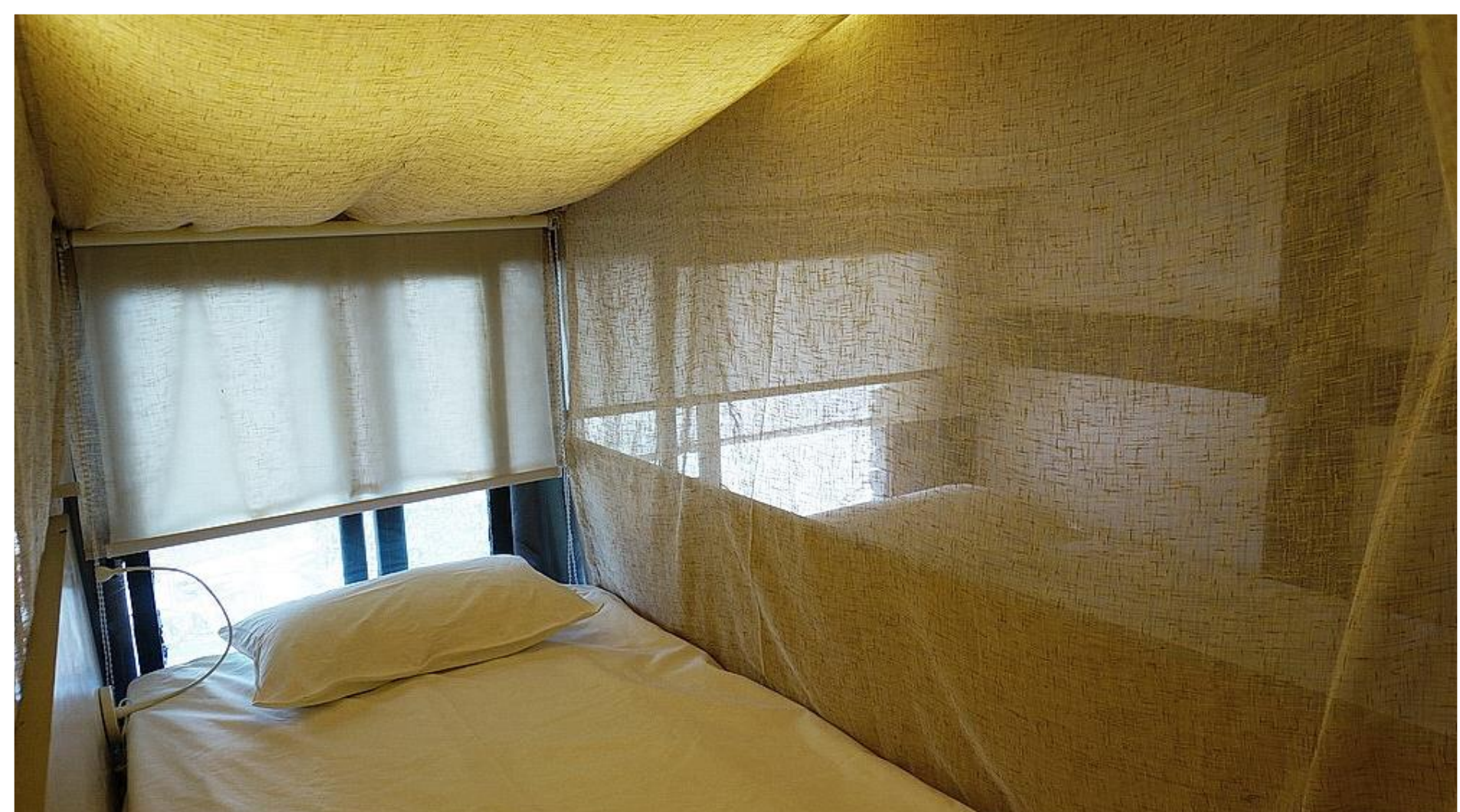





Back to the Rural | 2010s-

For Equality, For Sustainability

rural China as a new field of design innovations

Approach 2 \ Cultural Continuity







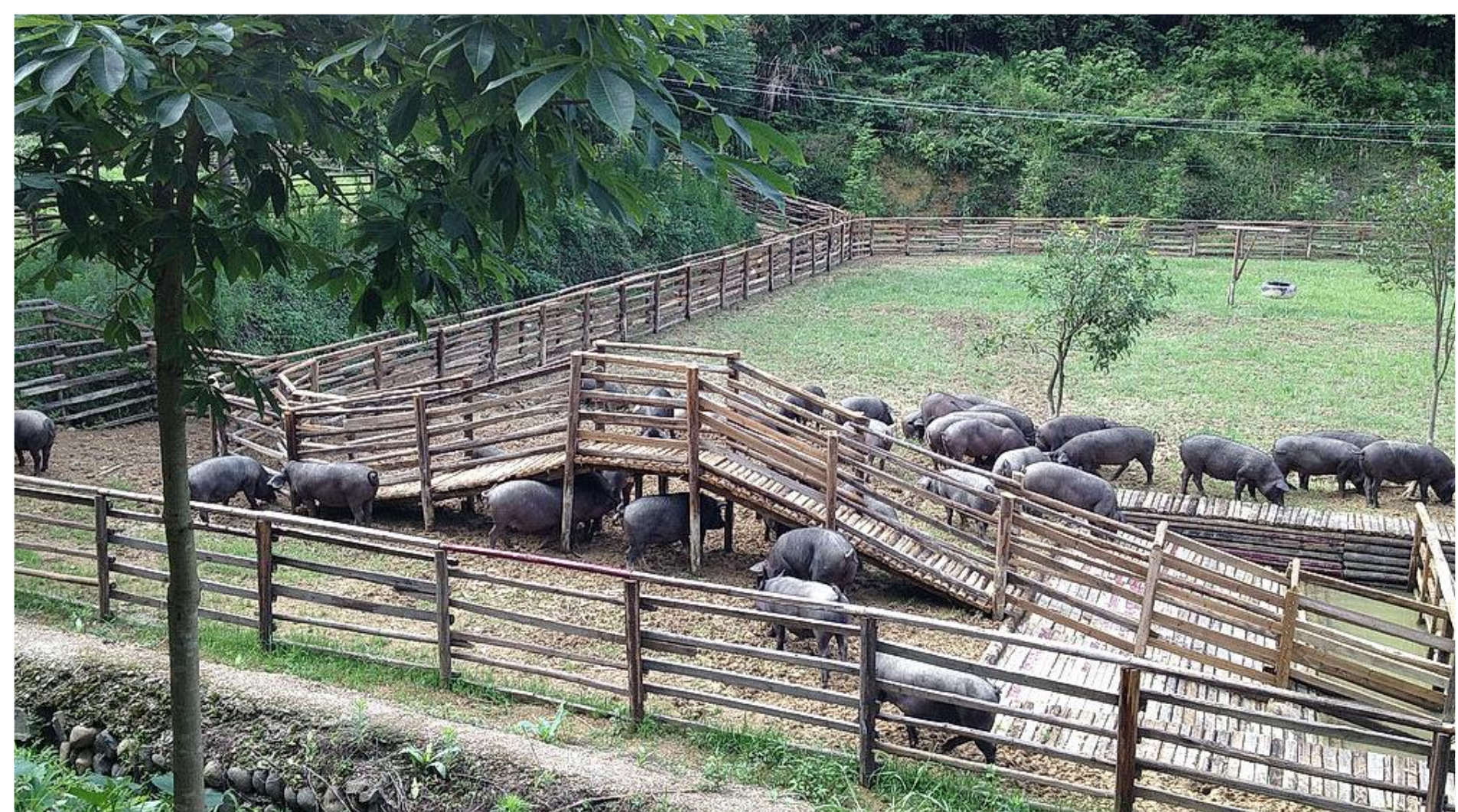



















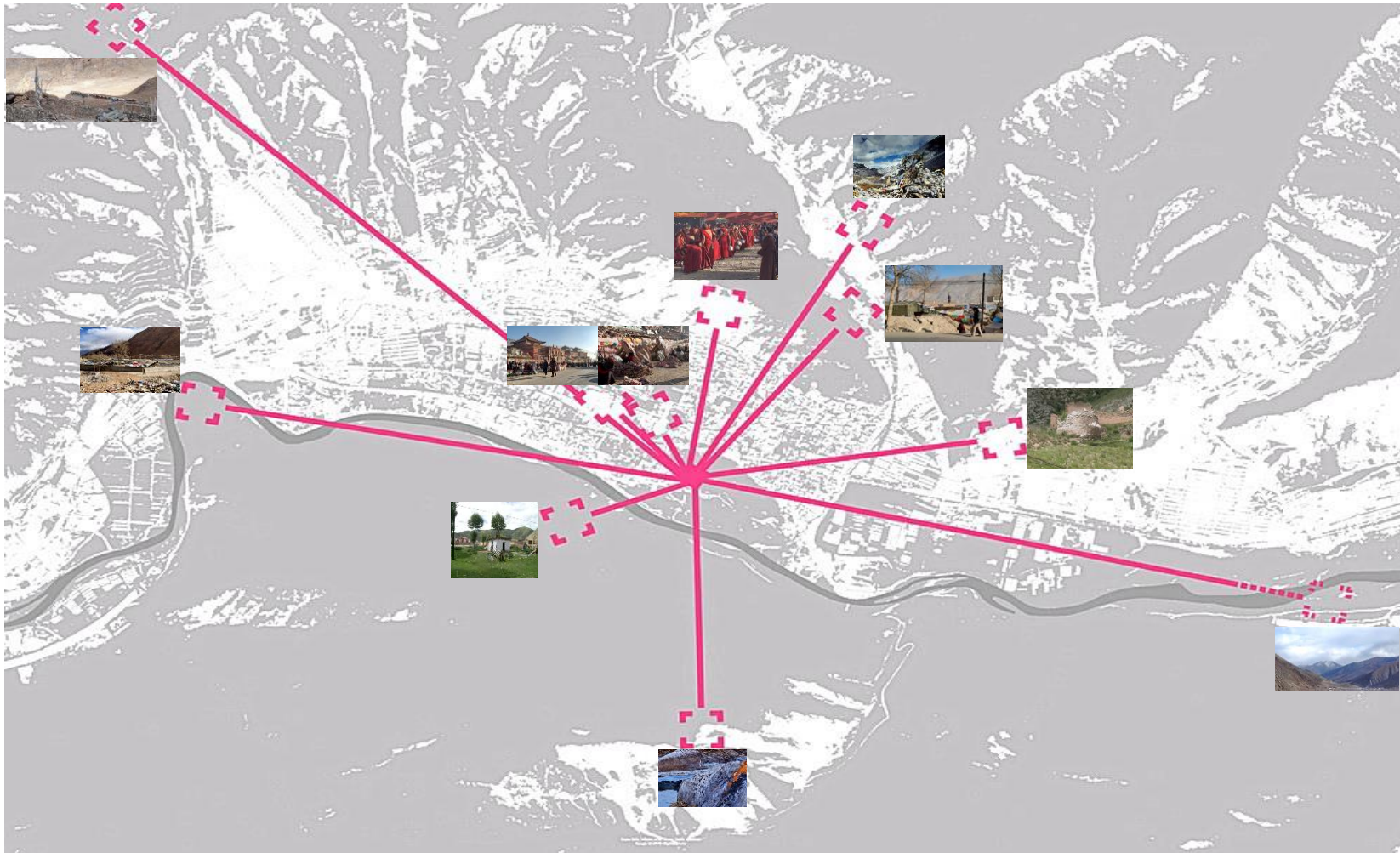















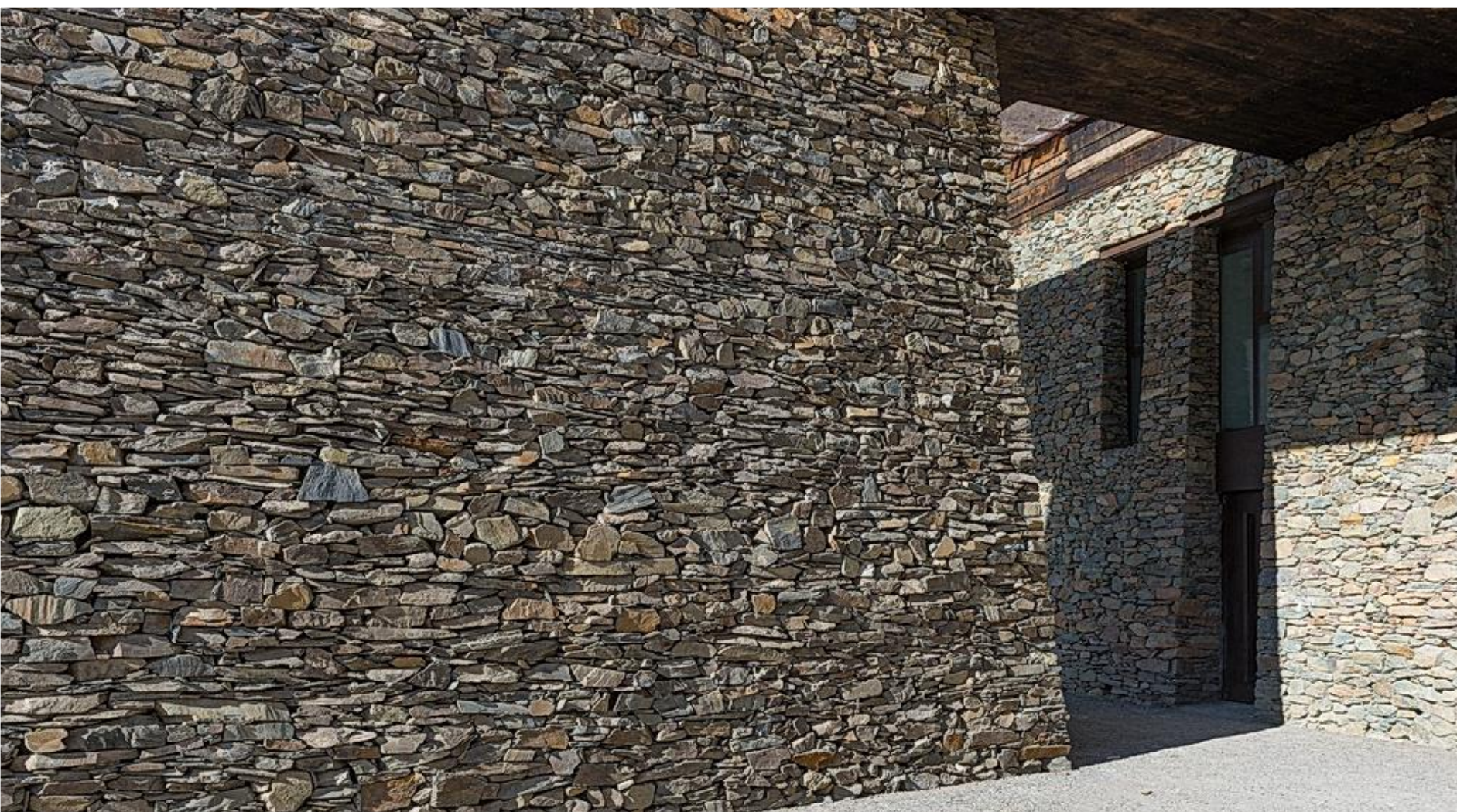





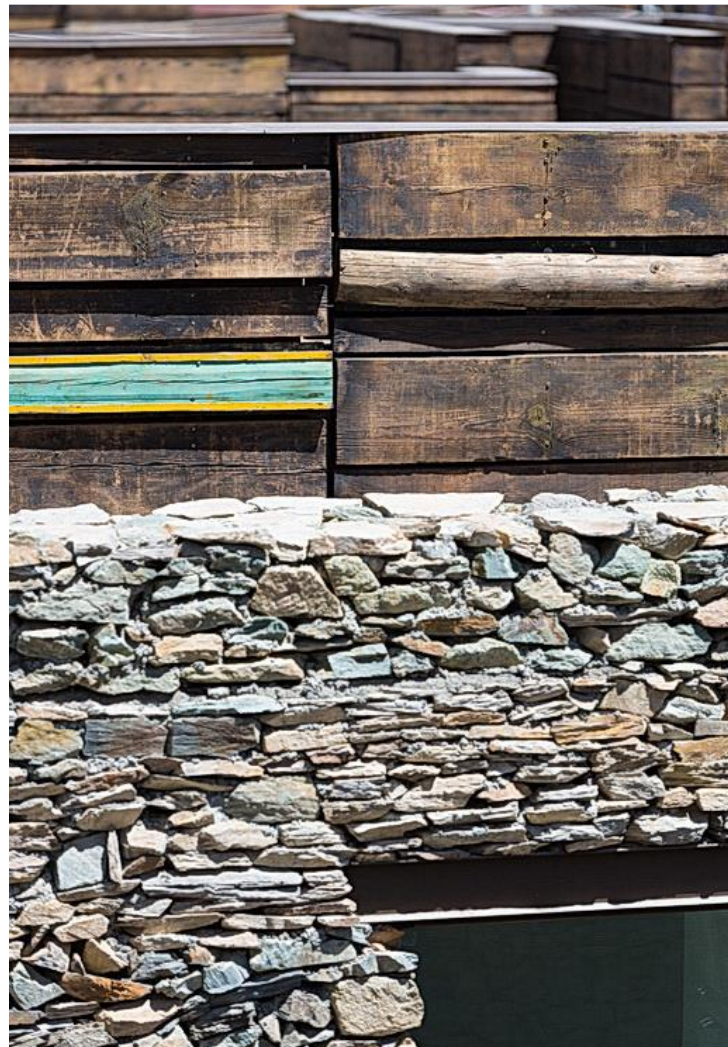







Back to the Rural | 2010s-

For Equality, For Sustainability

rural China as a new field of design innovations

Approach 3 \ Urban-Rural Blending



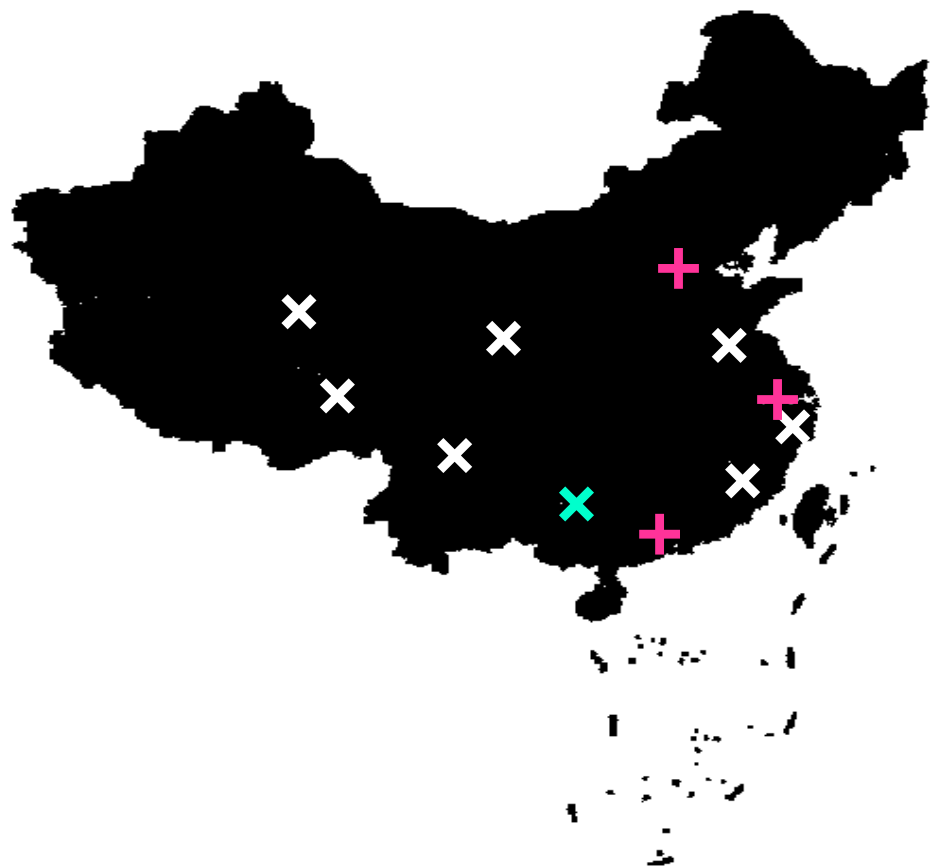









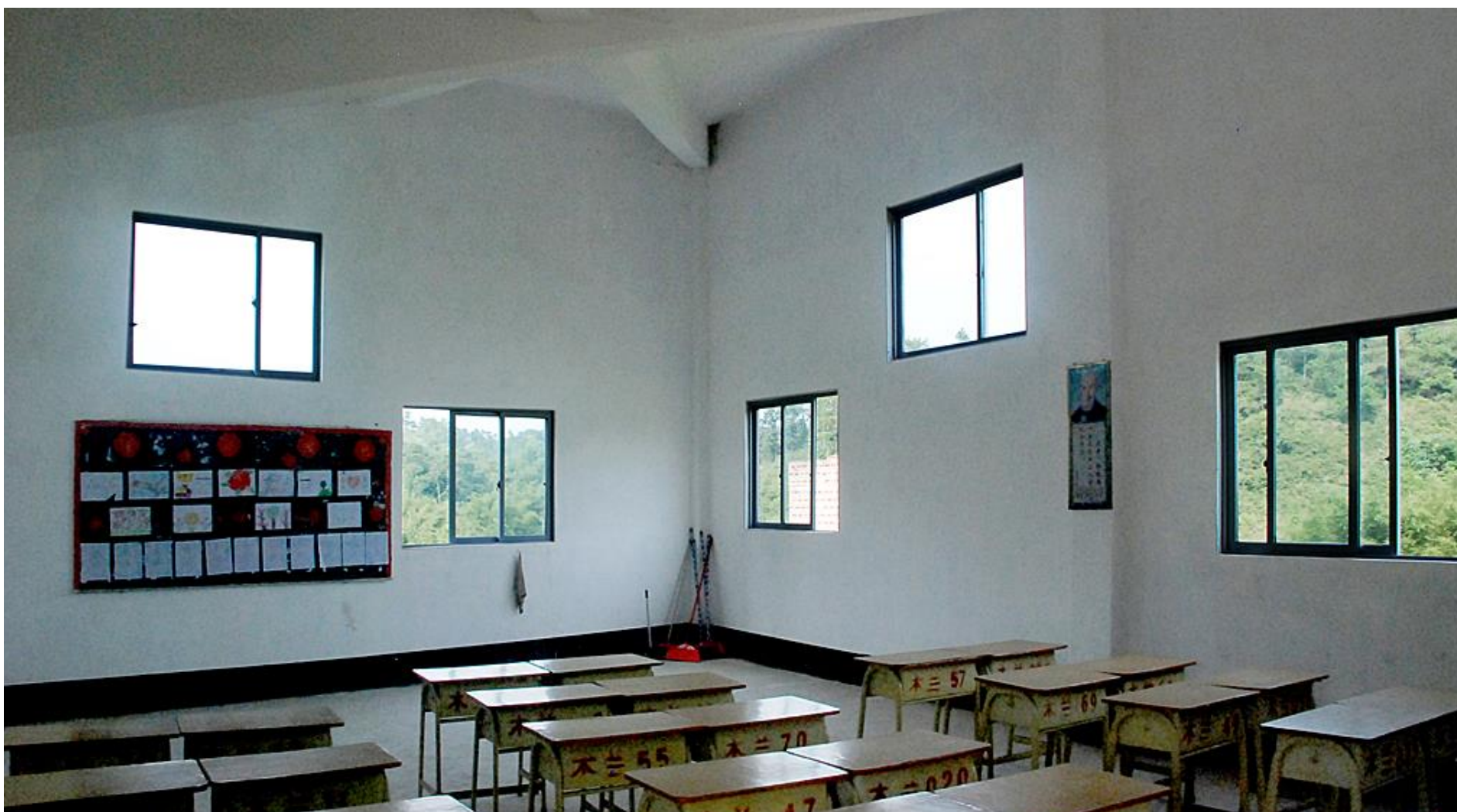









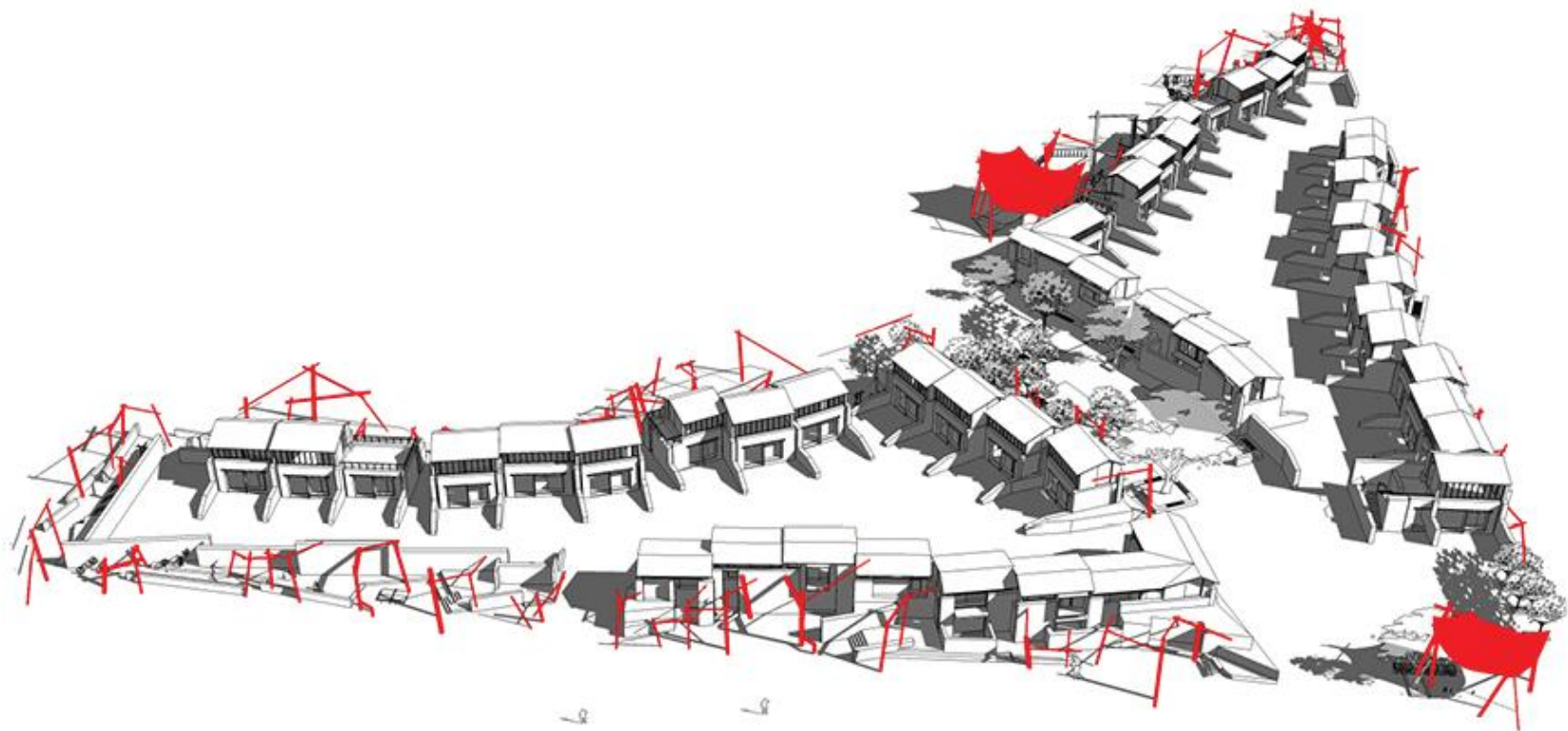



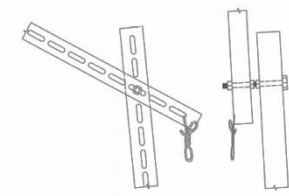
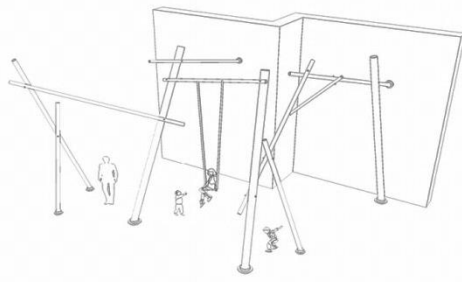
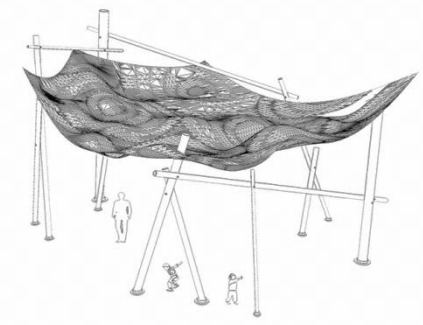
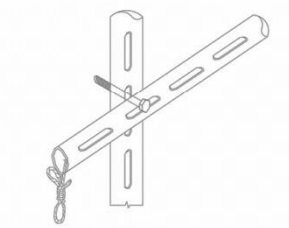
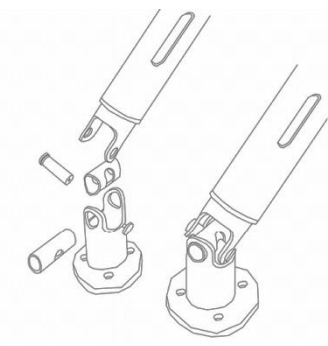
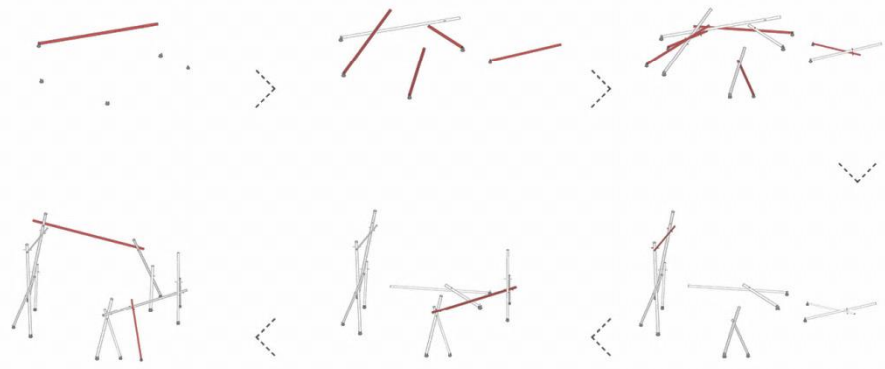







Back to the Rural | 2010s-

For Equality, For Sustainability  
rural China as a new field of design innovations

Approach 4 \ Individual Resettlement







































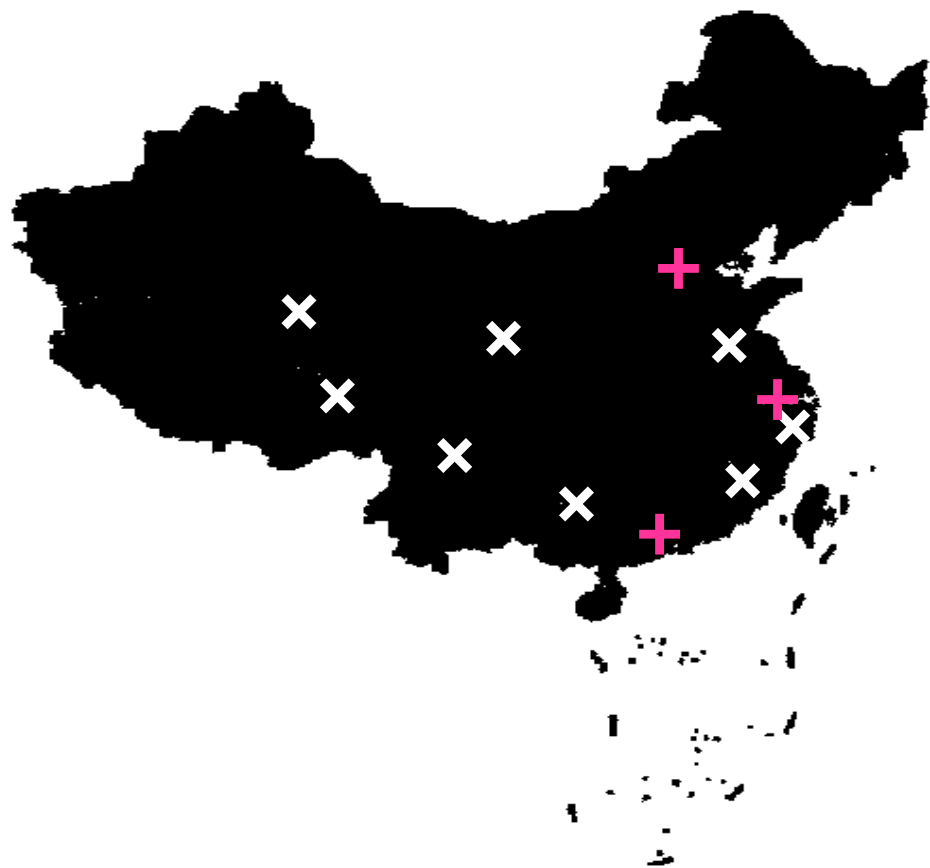

*Modern*

**Urban**

**1980S-2000S**

*Contemporary*

**Rural**

**2010S-**

Value

**Consumerism**

**Man-nature Relationship**

Resource Pattern

**Concentration**

**Distribution**

Scale

**Big**

**Small**

Technologies

**Costly \ High-tech**

**Affordable \ Low-tech**

Economic Cycle

**Remove and Replace**

**Recycle and Reuse**

Mode of Change

**Top-down**

**Bottom-up**



**Back to Rural China:**  
a Field of *Sustainable Design Innovations*

GBS 2015 | Berlin, Nov 2015 | ZHANG, Li | Tsinghua University, China